

## P-Channel 60-V (D-S) MOSFET

<b>PRODUCT SUMMARY</b>			
$V_{DS(min.)}$ (V)	$R_{DS(on)}$ ( $\Omega$ )	$V_{GS(th)}$ (V)	$I_D$ (mA)
- 60	4.0 at $V_{GS} = - 10$ V	- 1 to 3.0	- 190

### FEATURES

- Halogen-free Option Available
- TrenchFET<sup>®</sup> Power MOSFETs
- High-Side Switching
- Low On-Resistance: 4  $\Omega$
- Low Threshold: - 2 V (typ.)
- Fast Switching Speed: 20 ns (typ.)
- Low Input Capacitance: 20 pF (typ.)
- Miniature Package
- ESD Protected: 2000 V



**RoHS**  
COMPLIANT

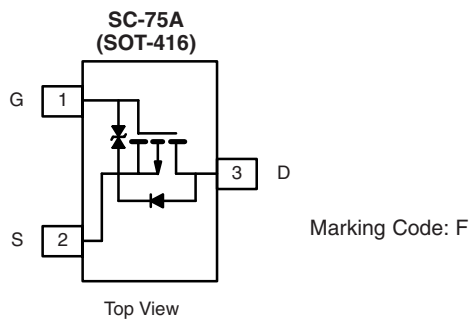

**Ordering Information:** Si1021R-T1-E3 (Lead (Pb)-free)  
Si1021R-T1-GE3 (Lead (Pb)-free and Halogen-free)

### APPLICATIONS

- Drivers: Relays, Solenoids, Lamps, Hammers, Displays, Memories, Transistors, etc.
- Battery Operated Systems
- Power Supply Converter Circuits
- Solid-State Relays

### BENEFITS

- Ease in Driving Switches
- Low Offset Voltage
- Low-Voltage Operation
- High-Speed Circuits
- Easily Driven without Buffer
- Small Board Area

<b>ABSOLUTE MAXIMUM RATINGS</b> $T_A = 25$ °C, unless otherwise noted			
Parameter	Symbol	Limit	Unit
Drain-Source Voltage	$V_{DS}$	- 60	V
Gate-Source Voltage	$V_{GS}$	$\pm 20$	
Continuous Drain Current ( $T_J = 150$ °C) <sup>a</sup>	$I_D$	$T_A = 25$ °C	- 190
		$T_A = 85$ °C	- 135
Pulsed Drain Current <sup>b</sup>	$I_{DM}$	- 650	mA
Power Dissipation <sup>a</sup>	$P_D$	$T_A = 25$ °C	250
		$T_A = 85$ °C	130
Maximum Junction-to-Ambient <sup>a</sup>	$R_{thJA}$	500	°C/W
Operating Junction and Storage Temperature Range	$T_J, T_{stg}$	- 55 to 150	°C

Notes:

- Surface mounted on FR4 board.
- Pulse width limited by maximum junction temperature.

<b>SPECIFICATIONS</b> $T_J = 25\text{ }^\circ\text{C}$ , unless otherwise noted						
Parameter	Symbol	Test Conditions	Min.	Typ.	Max.	Unit
<b>Static</b>						
Drain-Source Breakdown Voltage	$V_{DS}$	$V_{GS} = 0\text{ V}$ , $I_D = -10\text{ }\mu\text{A}$	- 60			V
Gate-Threshold Voltage	$V_{GS(th)}$	$V_{DS} = V_{GS}$ , $I_D = -0.25\text{ mA}$	- 1		- 3.0	
Gate-Body Leakage	$I_{GSS}$	$V_{DS} = 0\text{ V}$ , $V_{GS} = \pm 20\text{ V}$			$\pm 10$	$\mu\text{A}$
		$V_{DS} = 0\text{ V}$ , $V_{GS} = \pm 10\text{ V}$			$\pm 200$	
		$V_{DS} = 0\text{ V}$ , $V_{GS} = \pm 10\text{ V}$ , $T_J = 85\text{ }^\circ\text{C}$			$\pm 500$	
		$V_{DS} = 0\text{ V}$ , $V_{GS} = \pm 5\text{ V}$			$\pm 100$	nA
Zero Gate Voltage Drain Current	$I_{DSS}$	$V_{DS} = -50\text{ V}$ , $V_{GS} = 0\text{ V}$			- 25	
		$V_{DS} = -50\text{ V}$ , $V_{GS} = 0\text{ V}$ , $T_J = 85\text{ }^\circ\text{C}$			- 250	
On-State Drain Current <sup>a</sup>	$I_{D(on)}$	$V_{DS} = -10\text{ V}$ , $V_{GS} = -4.5\text{ V}$	- 50			mA
		$V_{DS} = -10\text{ V}$ , $V_{GS} = -10\text{ V}$	- 600			
Drain-Source On-State Resistance <sup>a</sup>	$R_{DS(on)}$	$V_{GS} = -4.5\text{ V}$ , $I_D = -25\text{ mA}$			8	
		$V_{GS} = -10\text{ V}$ , $I_D = -500\text{ mA}$			4	$\Omega$
		$V_{GS} = -10\text{ V}$ , $I_D = -500\text{ mA}$ , $T_J = 125\text{ }^\circ\text{C}$			6	
Forward Transconductance	$g_{fs}$	$V_{DS} = -10\text{ V}$ , $I_D = -100\text{ mA}$	80			mS
Diode Forward Voltage <sup>a</sup>	$V_{SD}$	$V_{DS} = -200\text{ mA}$ , $V_{GS} = 0\text{ V}$	80			V
<b>Dynamic</b>						
Total Gate Charge	$Q_g$	$V_{DS} = -30\text{ V}$ , $V_{GS} = -15\text{ V}$ , $I_D \cong -500\text{ mA}$		1.7		nC
Gate-Source Charge	$Q_{gs}$		0.26			
Gate-Drain Charge	$Q_{gd}$		0.46			
Input Capacitance	$C_{iss}$	$V_{DS} = -25\text{ V}$ , $V_{GS} = 0\text{ V}$ , $f = 1\text{ MHz}$		23		pF
Output Capacitance	$C_{oss}$		10			
Reverse Transfer Capacitance	$C_{rss}$		5			
<b>Switching<sup>b</sup></b>						
Turn-On Time	$t_{ON}$	$V_{DD} = -25\text{ V}$ , $R_L = 150\text{ }\Omega$		20		ns
Turn-Off Time	$t_{OFF}$	$I_D \cong -200\text{ mA}$ , $V_{GEN} = -10\text{ V}$ , $R_G = 10\text{ }\Omega$		35		

Notes:

a. Pulse test; pulse width  $\leq 300\text{ }\mu\text{s}$ , duty cycle  $\leq 2\%$ .

b. Switching time is essentially independent of operating temperature.

Stresses beyond those listed under "Absolute Maximum Ratings" may cause permanent damage to the device. These are stress ratings only, and functional operation of the device at these or any other conditions beyond those indicated in the operational sections of the specifications is not implied. Exposure to absolute maximum rating conditions for extended periods may affect device reliability.

**TYPICAL CHARACTERISTICS**  $T_A = 25\text{ }^\circ\text{C}$ , unless otherwise noted

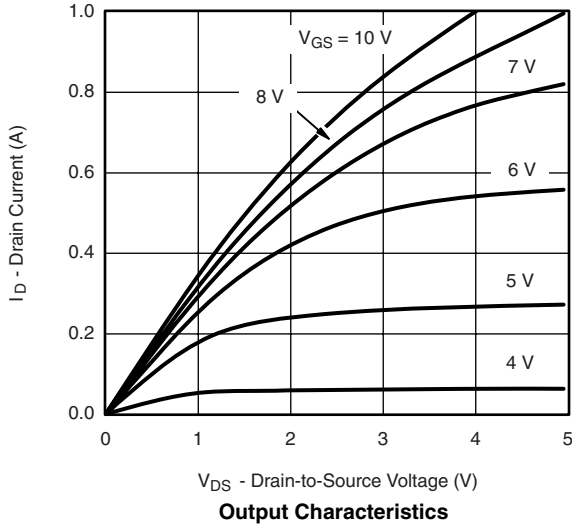

**Output Characteristics**

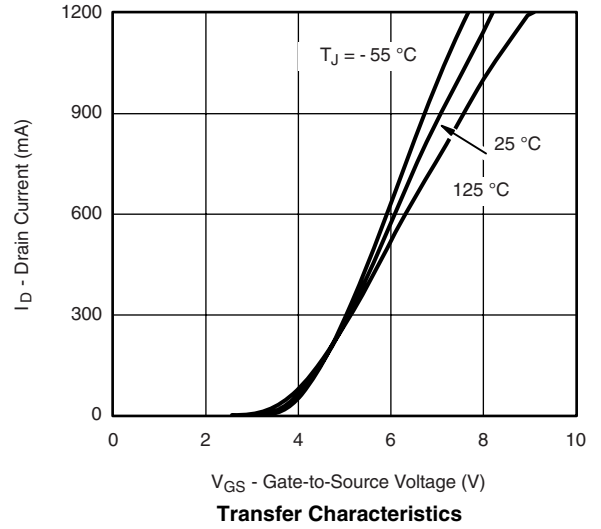

**Transfer Characteristics**

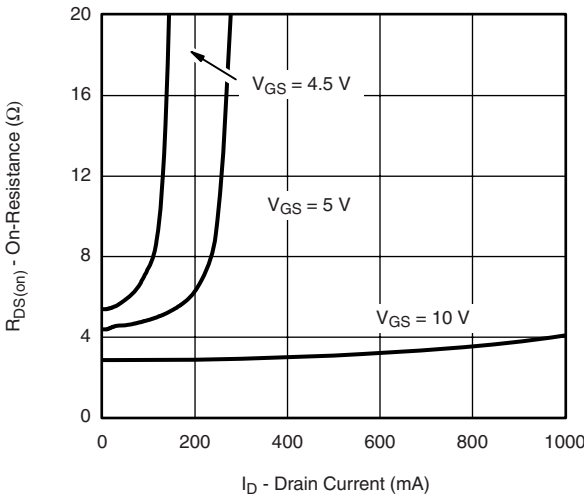

**On-Resistance vs. Drain Current**

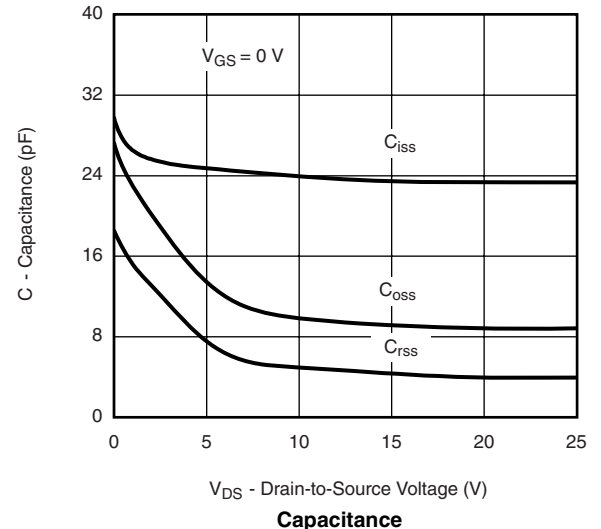

**Capacitance**

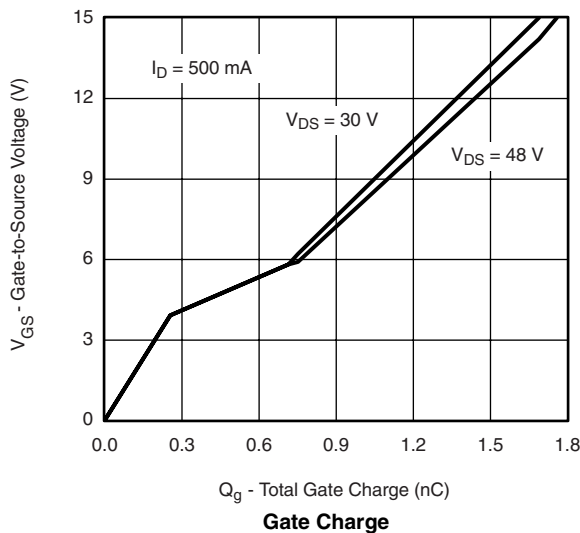

**Gate Charge**

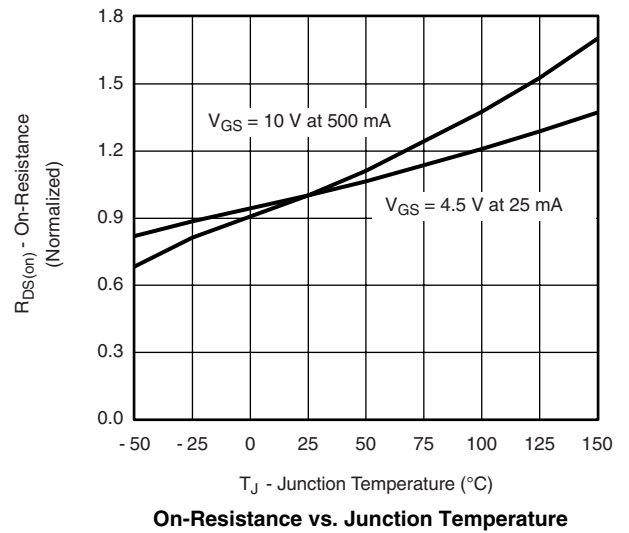

**On-Resistance vs. Junction Temperature**

### TYPICAL CHARACTERISTICS $T_A = 25\text{ }^\circ\text{C}$ , unless otherwise noted

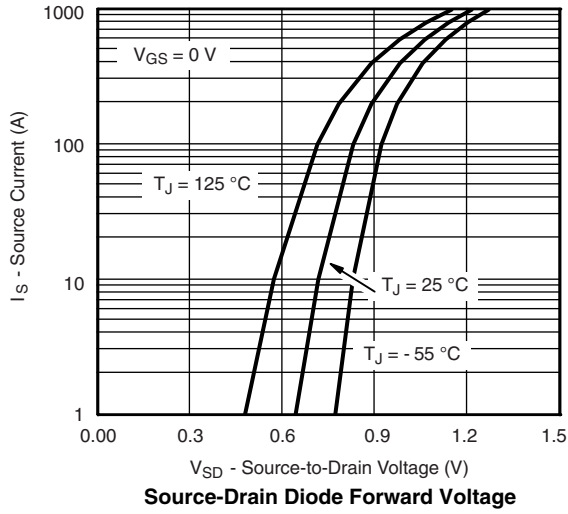

Source-Drain Diode Forward Voltage

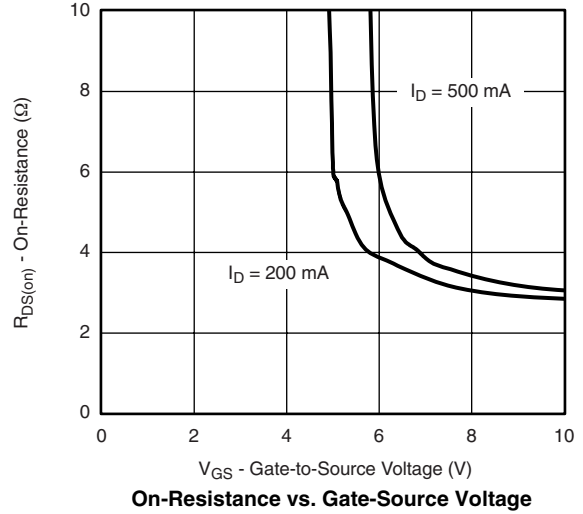

On-Resistance vs. Gate-Source Voltage

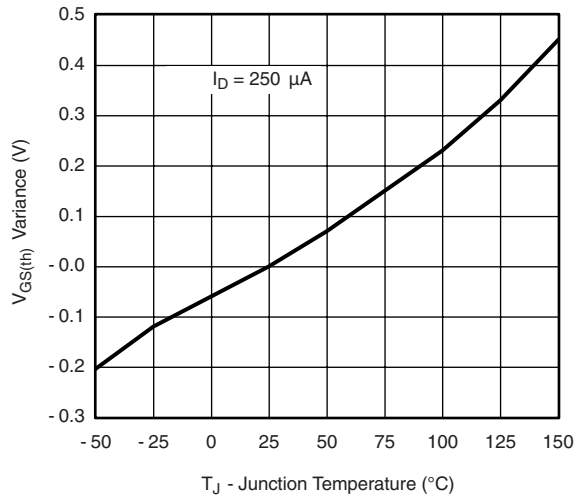

Threshold Voltage Variance Over Temperature

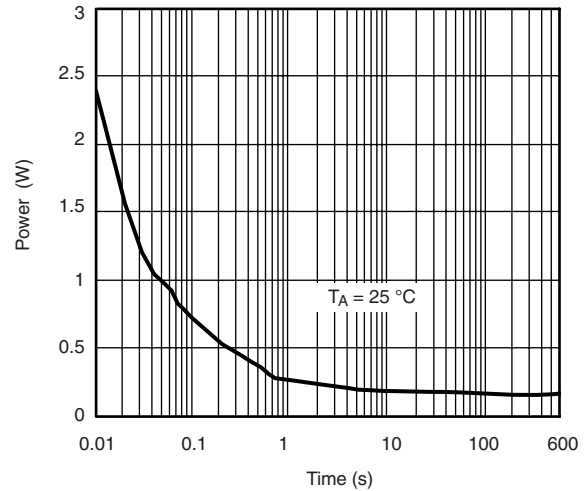

Single Pulse Power, Junction-to-Ambient

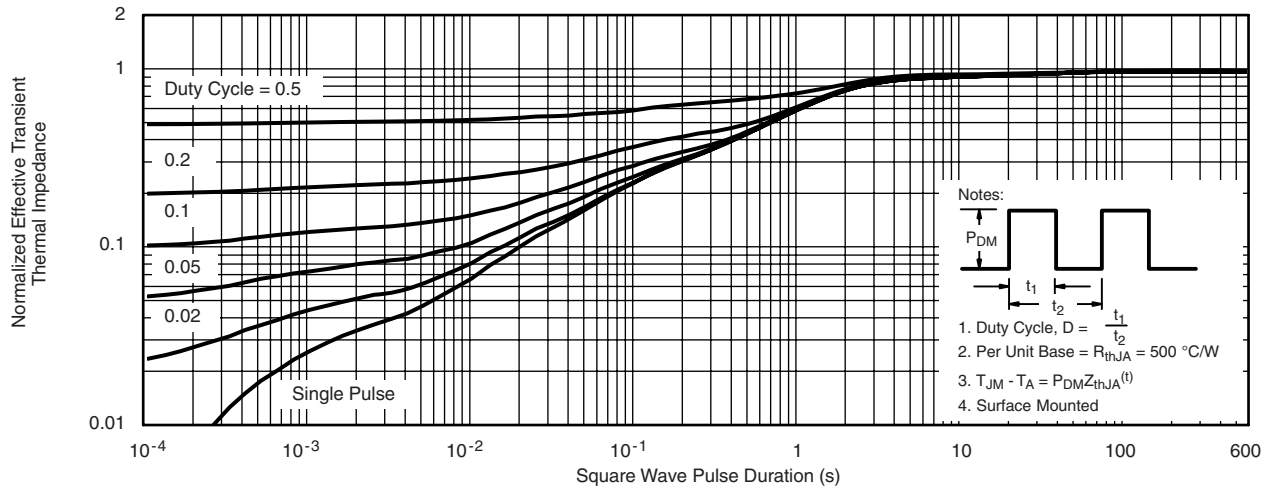

Normalized Thermal Transient Impedance, Junction-to-Ambient

Vishay Siliconix maintains worldwide manufacturing capability. Products may be manufactured at one of several qualified locations. Reliability data for Silicon Technology and Package Reliability represent a composite of all qualified locations. For related documents such as package/tape drawings, part marking, and reliability data, see <http://www.vishay.com/ppg71410>.



## Disclaimer

All product specifications and data are subject to change without notice.

Vishay Intertechnology, Inc., its affiliates, agents, and employees, and all persons acting on its or their behalf (collectively, "Vishay"), disclaim any and all liability for any errors, inaccuracies or incompleteness contained herein or in any other disclosure relating to any product.

Vishay disclaims any and all liability arising out of the use or application of any product described herein or of any information provided herein to the maximum extent permitted by law. The product specifications do not expand or otherwise modify Vishay's terms and conditions of purchase, including but not limited to the warranty expressed therein, which apply to these products.

No license, express or implied, by estoppel or otherwise, to any intellectual property rights is granted by this document or by any conduct of Vishay.

The products shown herein are not designed for use in medical, life-saving, or life-sustaining applications unless otherwise expressly indicated. Customers using or selling Vishay products not expressly indicated for use in such applications do so entirely at their own risk and agree to fully indemnify Vishay for any damages arising or resulting from such use or sale. Please contact authorized Vishay personnel to obtain written terms and conditions regarding products designed for such applications.

Product names and markings noted herein may be trademarks of their respective owners.